

**ASRock®**

***H470M-HDV***  
***H470M-HVS***

User Manual

Version 1.0

Published January 2021

Copyright©2021 ASRock INC. All rights reserved.

## Copyright Notice:

No part of this documentation may be reproduced, transcribed, transmitted, or translated in any language, in any form or by any means, except duplication of documentation by the purchaser for backup purpose, without written consent of ASRock Inc.

Products and corporate names appearing in this documentation may or may not be registered trademarks or copyrights of their respective companies, and are used only for identification or explanation and to the owners' benefit, without intent to infringe.

## Disclaimer:

Specifications and information contained in this documentation are furnished for informational use only and subject to change without notice, and should not be constructed as a commitment by ASRock. ASRock assumes no responsibility for any errors or omissions that may appear in this documentation.

With respect to the contents of this documentation, ASRock does not provide warranty of any kind, either expressed or implied, including but not limited to the implied warranties or conditions of merchantability or fitness for a particular purpose.

In no event shall ASRock, its directors, officers, employees, or agents be liable for any indirect, special, incidental, or consequential damages (including damages for loss of profits, loss of business, loss of data, interruption of business and the like), even if ASRock has been advised of the possibility of such damages arising from any defect or error in the documentation or product.



This device complies with Part 15 of the FCC Rules. Operation is subject to the following two conditions:

- (1) this device may not cause harmful interference, and
- (2) this device must accept any interference received, including interference that may cause undesired operation.

## CALIFORNIA, USA ONLY

The Lithium battery adopted on this motherboard contains Perchlorate, a toxic substance controlled in Perchlorate Best Management Practices (BMP) regulations passed by the California Legislature. When you discard the Lithium battery in California, USA, please follow the related regulations in advance.

“Perchlorate Material-special handling may apply, see [www.dtsc.ca.gov/hazardouswaste/perchlorate](http://www.dtsc.ca.gov/hazardouswaste/perchlorate)”

**ASRock Website: <http://www.asrock.com>**

## AUSTRALIA ONLY

Our goods come with guarantees that cannot be excluded under the Australian Consumer Law. You are entitled to a replacement or refund for a major failure and compensation for any other reasonably foreseeable loss or damage caused by our goods. You are also entitled to have the goods repaired or replaced if the goods fail to be of acceptable quality and the failure does not amount to a major failure. If you require assistance please call ASRock Tel : +886-2-28965588 ext.123 (Standard International call charges apply)

The terms HDMI® and HDMI High-Definition Multimedia Interface, and the HDMI logo are trademarks or registered trademarks of HDMI Licensing LLC in the United States and other countries.



# Contents

<b>Chapter 1 Introduction</b>	<b>1</b>
1.1 Package Contents	1
1.2 Specifications	2
1.3 Motherboard Layout	6
1.4 I/O Panel	9
<b>Chapter 2 Installation</b>	<b>11</b>
2.1 Installing the CPU	12
2.2 Installing the CPU Fan and Heatsink	15
2.3 Installing Memory Modules (DIMM)	16
2.4 Expansion Slots (PCI Express Slots)	18
2.5 Jumpers Setup	19
2.6 Onboard Headers and Connectors	20
<b>Chapter 3 Software and Utilities Operation</b>	<b>24</b>
3.1 Installing Drivers	24
3.2 ASRock Motherboard Utility (A-Tuning)	25
3.2.1 Installing ASRock Motherboard Utility (A-Tuning)	25
3.2.2 Using ASRock Motherboard Utility (A-Tuning)	25
3.3 ASRock Live Update & APP Shop	28
3.3.1 UI Overview	28
3.3.2 Apps	29
3.3.3 BIOS & Drivers	32
3.3.4 Setting	33

<b>Chapter 4 UEFI SETUP UTILITY</b>	<b>34</b>
4.1 Introduction	34
4.2 EZ Mode	35
4.3 Advanced Mode	36
4.3.1 UEFI Menu Bar	36
4.3.2 Navigation Keys	37
4.4 Main Screen	38
4.5 OC Tweaker Screen	40
4.6 Advanced Screen	48
4.6.1 CPU Configuration	49
4.6.2 Chipset Configuration	51
4.6.3 Storage Configuration	54
4.6.4 Super IO Configuration	55
4.6.5 ACPI Configuration	56
4.6.6 USB Configuration	57
4.6.7 Trusted Computing	58
4.7 Tools	59
4.8 Hardware Health Event Monitoring Screen	61
4.9 Security Screen	63
4.10 Boot Screen	64
4.11 Exit Screen	67

# Chapter 1 Introduction

Thank you for purchasing ASRock H470M-HDV / H470M-HVS motherboard, a reliable motherboard produced under ASRock's consistently stringent quality control. It delivers excellent performance with robust design conforming to ASRock's commitment to quality and endurance.

In this documentation, Chapter 1 and 2 contains the introduction of the motherboard and step-by-step installation guides. Chapter 3 contains the operation guide of the software and utilities. Chapter 4 contains the configuration guide of the BIOS setup.



*Because the motherboard specifications and the BIOS software might be updated, the content of this documentation will be subject to change without notice. In case any modifications of this documentation occur, the updated version will be available on ASRock's website without further notice. If you require technical support related to this motherboard, please visit our website for specific information about the model you are using. You may find the latest VGA cards and CPU support list on ASRock's website as well. ASRock website <http://www.asrock.com>.*

## 1.1 Package Contents

- ASRock H470M-HDV / H470M-HVS Motherboard (Micro ATX Form Factor)
- ASRock H470M-HDV / H470M-HVS Quick Installation Guide
- ASRock H470M-HDV / H470M-HVS Support CD
- 2 x Serial ATA (SATA) Data Cables (Optional)
- 1 x I/O Panel Shield

## 1.2 Specifications

- Platform**
- Micro ATX Form Factor
  - Solid Capacitor design

- CPU**
- Supports 10<sup>th</sup> Gen Intel® Core™ Processors (Socket 1200)
  - Digi Power design
  - 5 Power Phase design
  - Supports Intel® Turbo Boost Max 3.0 Technology

- Chipset**
- Intel® H470

- Memory**
- Dual Channel DDR4 Memory Technology
  - 2 x DDR4 DIMM Slots
  - Supports DDR4 2933/2800/2666/2400/2133 non-ECC, unbuffered memory
- \* Please refer to Memory Support List on ASRock's website for more information. (<http://www.asrock.com/>)
- \* Core™ (i9/i7) support DDR4 up to 2933; Core™ (i5/i3), Pentium® and Celeron® support DDR4 up to 2666.
- Supports ECC UDIMM memory modules (operate in non-ECC mode)
  - Max. capacity of system memory: 64GB
  - Supports Intel® Extreme Memory Profile (XMP) 2.0
  - 15µ Gold Contact in DIMM Slots

- Expansion Slot**
- 1 x PCI Express 3.0 x16 Slot
- \* Supports NVMe SSD as boot disks
- 1 x PCI Express 3.0 x1 Slot

- Graphics**
- Intel® UHD Graphics Built-in Visuals and the VGA outputs can be supported only with processors which are GPU integrated.
  - Hardware Accelerated Codecs: AVC/H.264, HEVC/H.265 8bit, HEVC/H.265 10bit, VP8, VP9 8bit, VP9 10bit, MPEG 2, MJPEG, VC-1
- \* VP9 10bit and VC-1 are for decode only.
- \* VP8 and VP9 encode are not supported by Windows OS.

- Graphics, Media & Compute: Microsoft DirectX 12, OpenGL 4.5, Intel® Built In Visuals, Intel® Quick Sync Video, Hybrid / Switchable Graphics, OpenCL 2.1
- Display & Content Security: Rec. 2020 (Wide Color Gamut), Microsoft PlayReady 3.0, Intel® SGX Content Protection, UHD/HDR Blu-ray Disc

**H470M-HDV:**

- Three graphics output options: D-Sub, DVI-D and HDMI
- Supports Triple Monitor
- Supports HDMI 1.4 with max. resolution up to 4K x 2K (4096x2160) @ 30Hz
- Supports DVI-D with max. resolution up to 1920x1200 @ 60Hz
- Supports D-Sub with max. resolution up to 1920x1200 @ 60Hz
- Supports Auto Lip Sync, Deep Color (12bpc), xvYCC and HBR (High Bit Rate Audio) with HDMI 1.4 Port (Compliant HDMI monitor is required)
- Supports HDCP 2.3 with DVI-D and HDMI 1.4 Ports
- Supports 4K Ultra HD (UHD) playback with HDMI 1.4 Port

**H470M-HVS:**

- Dual graphics output: support HDMI and D-Sub ports by independent display controllers
- Supports HDMI 1.4 with max. resolution up to 4K x 2K (4096x2160) @ 30Hz
- Supports D-Sub with max. resolution up to 1920x1200 @ 60Hz
- Supports Auto Lip Sync, Deep Color (12bpc), xvYCC and HBR (High Bit Rate Audio) with HDMI 1.4 Port (Compliant HDMI monitor is required)
- Supports HDCP 2.3 with HDMI 1.4 Port
- Supports 4K Ultra HD (UHD) playback with HDMI 1.4 Port

**Audio**

- 7.1 CH HD Audio (Realtek ALC897 Audio Codec)
- Supports Surge Protection

**LAN**

- PCIE x1 Gigabit LAN 10/100/1000 Mb/s
- Realtek RTL8111H
- Supports Wake-On-LAN



- Supports Lightning/ESD Protection
- Supports Energy Efficient Ethernet 802.3az
- Supports PXE

### **Rear Panel I/O**

- 1 x PS/2 Mouse/Keyboard Port
- 4 x USB 2.0 Ports (Supports ESD Protection)
- 2 x USB 3.2 Gen1 Ports (Supports ESD Protection)
- 1 x RJ-45 LAN Port with LED (ACT/LINK LED and SPEED LED)
- HD Audio Jacks: Line in / Front Speaker / Microphone

#### **H470M-HDV:**

- 1 x D-Sub Port
- 1 x DVI-D Port
- 1 x HDMI Port

#### **H470M-HVS:**

- 1 x D-Sub Port
- 1 x HDMI Port

### **Storage**

- 4 x SATA3 6.0 Gb/s Connectors, support RAID (RAID 0, RAID 1, RAID 5, RAID 10, Intel Rapid Storage Technology 17), NCQ, AHCI and Hot Plug

### **Connector**

- 1 x SPI TPM Header
- 1 x Chassis Intrusion and Speaker Header
- 1 x CPU Fan Connector (4-pin)
- \* The CPU Fan Connector supports the CPU fan of maximum 1A (12W) fan power.
- 1 x Chassis/Water Pump Fan Connector (4-pin) (Smart Fan Speed Control)
- \* The Chassis/Water Pump Fan supports the water cooler fan of maximum 2A (24W) fan power.
- \* CHA\_FAN1/WP can auto detect if 3-pin or 4-pin fan is in use.
- 1 x 24 pin ATX Power Connector
- 1 x 8 pin 12V Power Connector
- 1 x Front Panel Audio Connector
- 1 x USB 2.0 Header (Supports 2 USB 2.0 ports) (Supports ESD Protection)
- 1 x USB 3.2 Gen1 Header (Supports 2 USB 3.2 Gen1 ports) (Supports ESD Protection)

**BIOS  
Feature**

- AMI UEFI Legal BIOS with multilingual GUI support
- ACPI 6.0 Compliant wake up events
- SMBIOS 2.7 Support
- CPU Core/Cache, GT, DRAM, PCH +1.0V, VCCST Voltage Multi-adjustment

**Hardware  
Monitor**

- Temperature Sensing: CPU, Chassis/Water Pump Fans
- Fan Tachometer: CPU, Chassis/Water Pump Fans
- Quiet Fan (Auto adjust chassis fan speed by CPU temperature): CPU, Chassis/Water Pump Fans
- Fan Multi-Speed Control: CPU, Chassis/Water Pump Fans
- CASE OPEN detection
- Voltage monitoring: +12V, +5V, +3.3V, CPU Vcore, PCH +1.0V

**OS**

- Microsoft® Windows® 10 64-bit

**Certifica-  
tions**

- FCC, CE
- ErP/EuP ready (ErP/EuP ready power supply is required)

\* For detailed product information, please visit our website: <http://www.asrock.com>



*Please realize that there is a certain risk involved with overclocking, including adjusting the setting in the BIOS, applying Untied Overclocking Technology, or using third-party overclocking tools. Overclocking may affect your system's stability, or even cause damage to the components and devices of your system. It should be done at your own risk and expense. We are not responsible for possible damage caused by overclocking.*

### 1.3 Motherboard Layout

#### H470M-HDV:

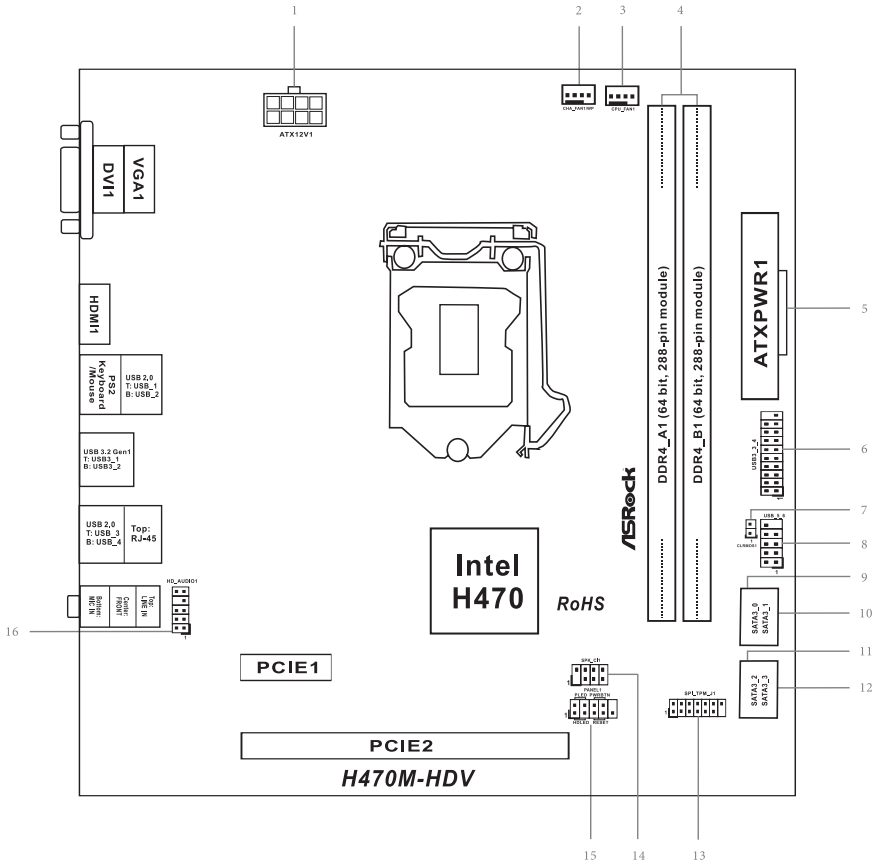

H470M-HVS:

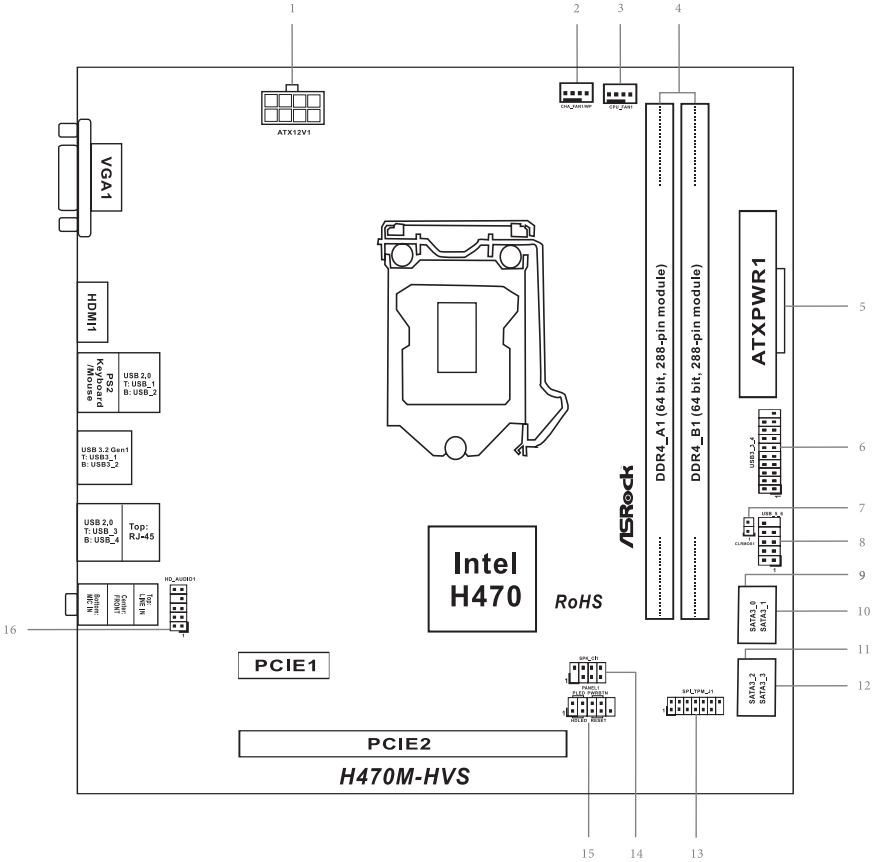

No.	Description
1	ATX 12V Power Connector (ATX12V1)
2	Chassis/Water Pump Fan Connector (CHA_FAN1/WP)
3	CPU Fan Connector (CPU_FAN1)
4	2 x 288-pin DDR4 DIMM Slots (DDR4_A1, DDR4_B1)
5	ATX Power Connector (ATXPWR1)
6	USB 3.2 Gen1 Header (USB3_3_4)
7	Clear CMOS Jumper (CLRMOS1)
8	USB 2.0 Header (USB_5_6)
9	SATA3 Connector (SATA3_0)
10	SATA3 Connector (SATA3_1)
11	SATA3 Connector (SATA3_2)
12	SATA3 Connector (SATA3_3)
13	SPI TPM Header (SPI_TPM_J1)
14	Chassis Intrusion and Speaker Header (SPK_CI1)
15	System Panel Header (PANEL1)
16	Front Panel Audio Header (HD_AUDIO1)

## 1.4 I/O Panel

### H470M-HDV:

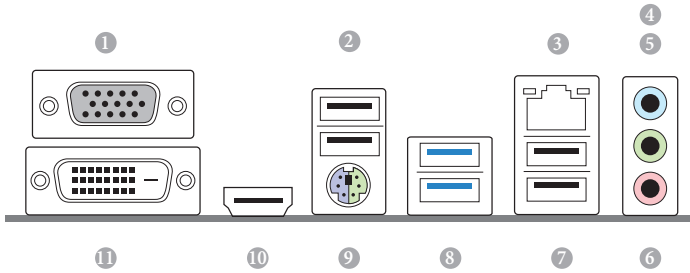

No.	Description	No.	Description
1	D-Sub Port	7	USB 2.0 Ports (USB_34)
2	USB 2.0 Ports (USB_12)	8	USB 3.2 Gen1 Ports (USB3_12)
3	LAN RJ-45 Port*	9	PS/2 Mouse/Keyboard Port
4	Line In (Light Blue)**	10	HDMI Port
5	Front Speaker (Lime)**	11	DVI-D Port
6	Microphone (Pink)**		

### H470M-HVS:

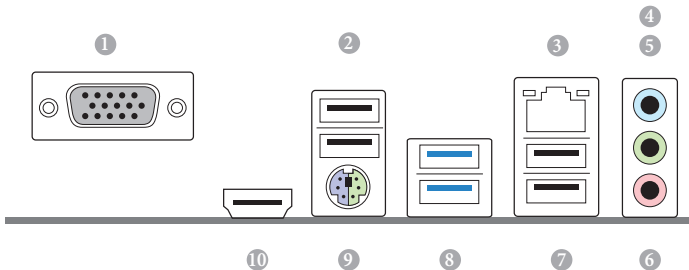

No.	Description	No.	Description
1	D-Sub Port	6	Microphone (Pink)**
2	USB 2.0 Ports (USB_12)	7	USB 2.0 Ports (USB_34)
3	LAN RJ-45 Port*	8	USB 3.2 Gen1 Ports (USB3_12)
4	Line In (Light Blue)**	9	PS/2 Mouse/Keyboard Port
5	Front Speaker (Lime)**	10	HDMI Port

\* There are two LEDs on each LAN port. Please refer to the table below for the LAN port LED indications.

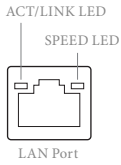

Activity / Link LED		Speed LED	
Status	Description	Status	Description
Off	No Link	Off	10Mbps connection
Blinking	Data Activity	Orange	100Mbps connection
On	Link	Green	1Gbps connection

\*\* *Function of the Audio Ports in 7.1-channel Configuration:*

Port	Function
Light Blue (Rear panel)	Rear Speaker Out
Lime (Rear panel)	Front Speaker Out
Pink (Rear panel)	Central /Subwoofer Speaker Out
Lime (Front panel)	Side Speaker Out

## Chapter 2 Installation

This is a Micro ATX form factor motherboard. Before you install the motherboard, study the configuration of your chassis to ensure that the motherboard fits into it.

### Pre-installation Precautions

Take note of the following precautions before you install motherboard components or change any motherboard settings.

- Make sure to unplug the power cord before installing or removing the motherboard components. Failure to do so may cause physical injuries and damages to motherboard components.
- In order to avoid damage from static electricity to the motherboard's components, NEVER place your motherboard directly on a carpet. Also remember to use a grounded wrist strap or touch a safety grounded object before you handle the components.
- Hold components by the edges and do not touch the ICs.
- Whenever you uninstall any components, place them on a grounded anti-static pad or in the bag that comes with the components.
- When placing screws to secure the motherboard to the chassis, please do not over-tighten the screws! Doing so may damage the motherboard.



## 2.1 Installing the CPU



1. Before you insert the 1200-Pin CPU into the socket, please check if the **PnP cap** is on the socket, if the CPU surface is unclean, or if there are any **bent pins** in the socket. Do not force to insert the CPU into the socket if above situation is found. Otherwise, the CPU will be seriously damaged.
2. Unplug all power cables before installing the CPU.

1

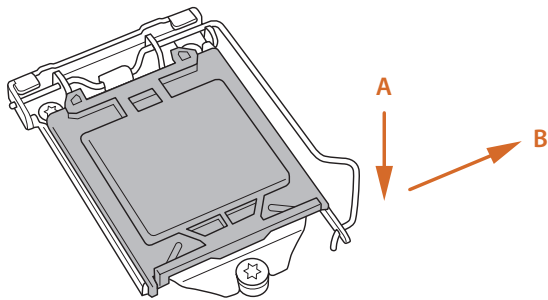

2

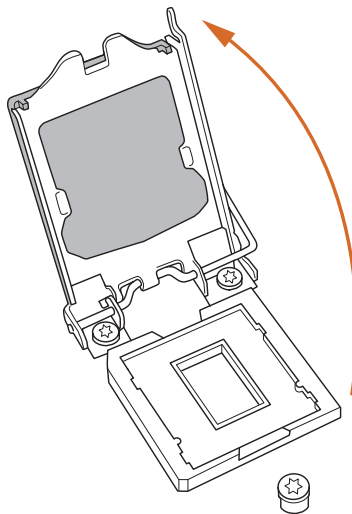

3

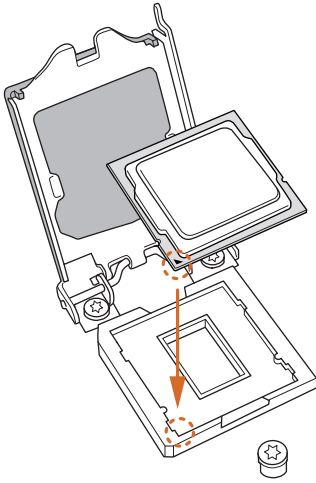

4

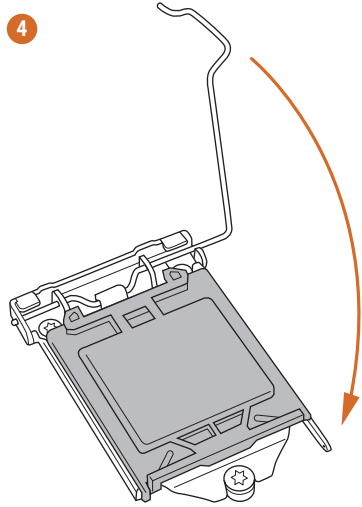

5

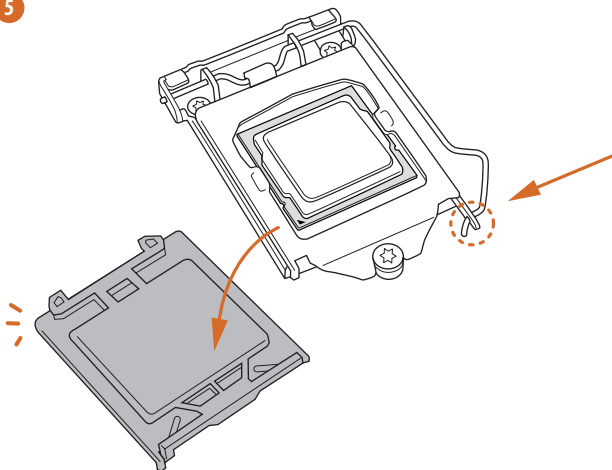



*Please save and replace the cover if the processor is removed. The cover must be placed if you wish to return the motherboard for after service.*

## 2.2 Installing the CPU Fan and Heatsink

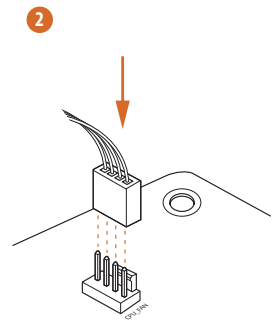
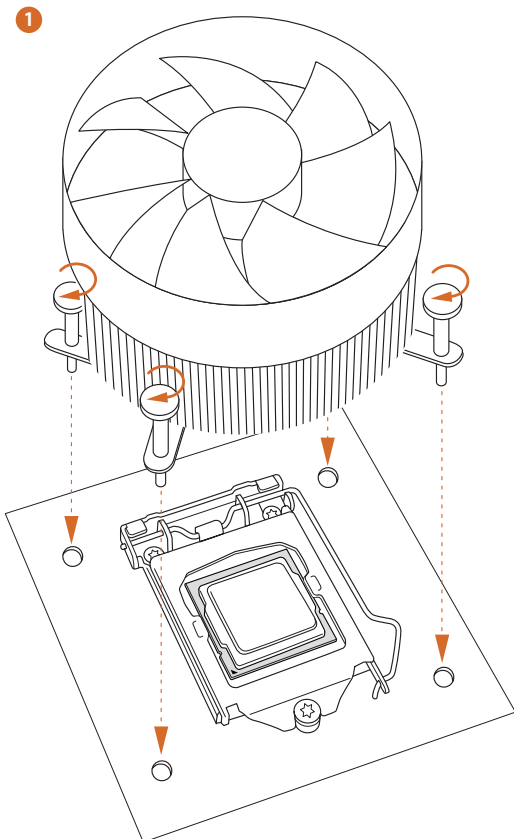
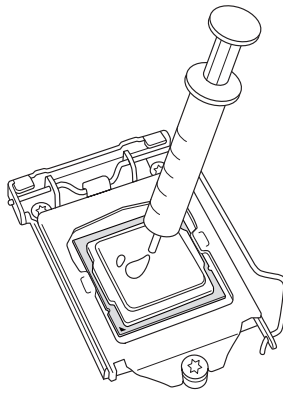

## 2.3 Installing Memory Modules (DIMM)

This motherboard provides two 288-pin DDR4 (Double Data Rate 4) DIMM slots, and supports Dual Channel Memory Technology.



1. For dual channel configuration, you always need to install identical (the same brand, speed, size and chip-type) DDR4 DIMM pairs.
2. It is unable to activate Dual Channel Memory Technology with only one memory module installed.
3. It is not allowed to install a DDR, DDR2 or DDR3 memory module into a DDR4 slot; otherwise, this motherboard and DIMM may be damaged.



*The DIMM only fits in one correct orientation. It will cause permanent damage to the motherboard and the DIMM if you force the DIMM into the slot at incorrect orientation.*

1

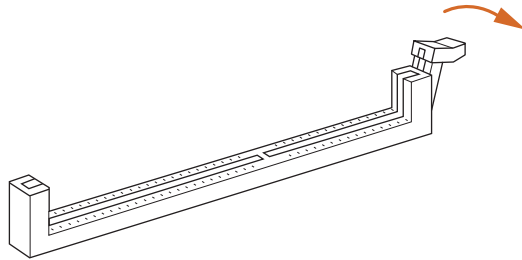

2

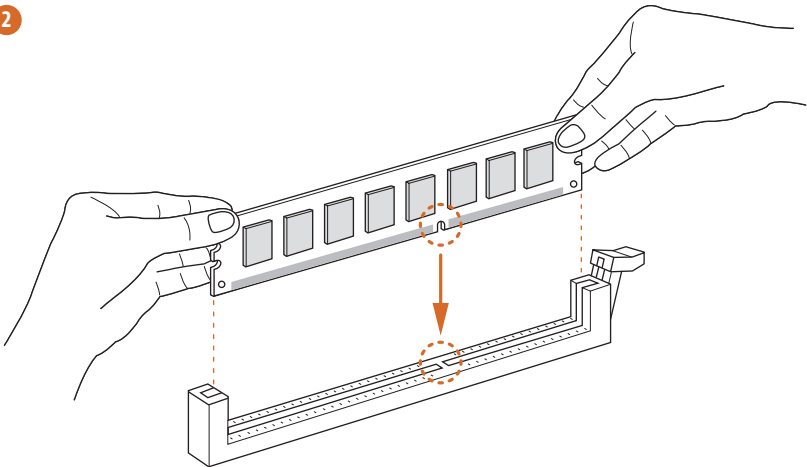

3

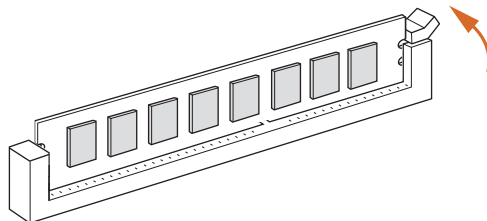

---

## 2.4 Expansion Slots (PCI Express Slots)

There are 2 PCI Express slots on the motherboard.



*Before installing an expansion card, please make sure that the power supply is switched off or the power cord is unplugged. Please read the documentation of the expansion card and make necessary hardware settings for the card before you start the installation.*

### **PCIe slots:**

PCI E1 (PCIe 3.0 x1 slot) is used for PCI Express x1 lane width cards.

PCI E2 (PCIe 3.0 x16 slot) is used for PCI Express x16 lane width graphics cards.

## 2.5 Jumpers Setup

The illustration shows how jumpers are setup. When the jumper cap is placed on the pins, the jumper is “Short”. If no jumper cap is placed on the pins, the jumper is “Open”.

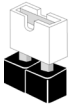

Short



Open

Clear CMOS Jumper  
(CLRMOSE1)  
(see p.6, 7, No. 7)



2-pin Jumper

Short: Clear CMOS  
Open: Default

CLRMOSE1 allows you to clear the data in CMOS. The data in CMOS includes system setup information such as system password, date, time, and system setup parameters. To clear and reset the system parameters to default setup, please turn off the computer and unplug the power cord, then use a jumper cap to short the pins on CLRMOSE1 for 3 seconds. Please remember to remove the jumper cap after clearing the CMOS. If you need to clear the CMOS when you just finish updating the BIOS, you must boot up the system first, and then shut it down before you do the clear-CMOS action.



*If you clear the CMOS, the case open may be detected. Please adjust the BIOS option “Clear Status” to clear the record of previous chassis intrusion status.*



## 2.6 Onboard Headers and Connectors



Onboard headers and connectors are NOT jumpers. Do NOT place jumper caps over these headers and connectors. Placing jumper caps over the headers and connectors will cause permanent damage to the motherboard.

System Panel Header  
(9-pin PANEL1)  
(see p.6, 7, No. 15)

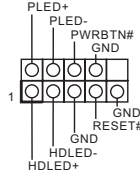

Connect the power button, reset button and system status indicator on the chassis to this header according to the pin assignments below. Note the positive and negative pins before connecting the cables.



**PWRBTN (Power Button):**

Connect to the power button on the chassis front panel. You may configure the way to turn off your system using the power button.

**RESET (Reset Button):**

Connect to the reset button on the chassis front panel. Press the reset button to restart the computer if the computer freezes and fails to perform a normal restart.

**PLED (System Power LED):**

Connect to the power status indicator on the chassis front panel. The LED is on when the system is operating. The LED keeps blinking when the system is in S1/S3 sleep state. The LED is off when the system is in S4 sleep state or powered off (S5).

**HDLED (Hard Drive Activity LED):**

Connect to the hard drive activity LED on the chassis front panel. The LED is on when the hard drive is reading or writing data.

The front panel design may differ by chassis. A front panel module mainly consists of power button, reset button, power LED, hard drive activity LED, speaker and etc. When connecting your chassis front panel module to this header, make sure the wire assignments and the pin assignments are matched correctly.

Chassis Intrusion and  
Speaker Header  
(7-pin SPK\_C11)  
(see p.6, 7, No. 14)

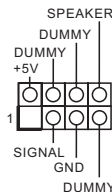

Please connect the chassis intrusion and the chassis speaker to this header.

Serial ATA3 Connectors

Right Angle:

- (SATA3\_0: see p.6, 7, No. 9)
- (SATA3\_1: see p.6, 7, No. 10)
- (SATA3\_2: see p.6, 7, No. 11)
- (SATA3\_3: see p.6, 7, No. 12)

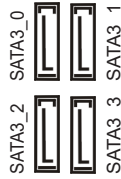

These four SATA3 connectors support SATA data cables for internal storage devices with up to 6.0 Gb/s data transfer rate.

- USB 2.0 Header (9-pin USB\_5\_6) (see p.6, 7, No. 8)

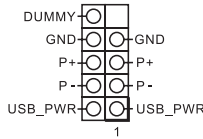

There is one header on this motherboard. This USB 2.0 header can support two ports.

- USB 3.2 Gen1 Header (19-pin USB3\_3\_4) (see p.6, 7, No. 6)

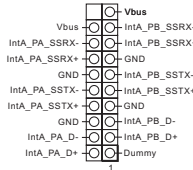

There is one header on this motherboard. This USB 3.2 Gen1 header can support two ports.

- Front Panel Audio Header (9-pin HD\_AUDIO1) (see p.6, 7, No. 16)

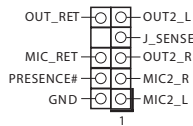

This header is for connecting audio devices to the front audio panel.



1. High Definition Audio supports Jack Sensing, but the panel wire on the chassis must support HDA to function correctly. Please follow the instructions in our manual and chassis manual to install your system.
2. If you use an AC'97 audio panel, please install it to the front panel audio header by the steps below:
  - A. Connect Mic\_IN (MIC) to MIC2\_L.
  - B. Connect Audio\_R (RIN) to OUT2\_R and Audio\_L (LIN) to OUT2\_L.
  - C. Connect Ground (GND) to Ground (GND).
  - D. MIC\_RET and OUT\_RET are for the HD audio panel only. You don't need to connect them for the AC'97 audio panel.
  - E. To activate the front mic, go to the "FrontMic" Tab in the Realtek Control panel and adjust "Recording Volume".

---

Chassis/Water Pump Fan  
Connector

(4-pin CHA\_FAN1/WP)  
(see p.6, 7, No. 2)

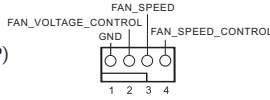

This motherboard provides one 4-Pin water cooling chassis fan connector. If you plan to connect a 3-Pin chassis water cooler fan, please connect it to Pin 1-3.

---

CPU Fan Connector

(4-pin CPU\_FAN1)  
(see p.6, 7, No. 3)

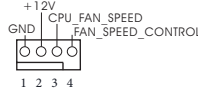

This motherboard provides a 4-Pin CPU fan (Quiet Fan) connector. If you plan to connect a 3-Pin CPU fan, please connect it to Pin 1-3.

---

ATX Power Connector

(24-pin ATXPWR1)  
(see p.6, 7, No. 5)

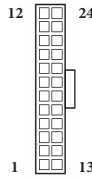

This motherboard provides a 24-pin ATX power connector. To use a 20-pin ATX power supply, please plug it along Pin 1 and Pin 13.

---

ATX 12V Power  
Connector

(8-pin ATX12V1)  
(see p.6, 7, No. 1)

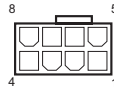

This motherboard provides a 8-pin ATX 12V power connector. To use a 4-pin ATX power supply, please plug it along Pin 1 and Pin 5.

**\*Warning: Please make sure that the power cable connected is for the CPU and not the graphics card. Do not plug the PCIe power cable to this connector.**

SPI TPM Header  
(13-pin SPI\_TPM\_J1)  
(see p.6, 7, No. 13)

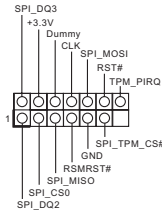

This connector supports SPI Trusted Platform Module (TPM) system, which can securely store keys, digital certificates, passwords, and data. A TPM system also helps enhance network security, protects digital identities, and ensures platform integrity.

---

## Chapter 3 Software and Utilities Operation

### 3.1 Installing Drivers

The Support CD that comes with the motherboard contains necessary drivers and useful utilities that enhance the motherboard's features.

#### Running The Support CD

To begin using the support CD, insert the CD into your CD-ROM drive. The CD automatically displays the Main Menu if "AUTORUN" is enabled in your computer. If the Main Menu does not appear automatically, locate and double click on the file "ASRSETUP.EXE" in the Support CD to display the menu.

#### Drivers Menu

The drivers compatible to your system will be auto-detected and listed on the support CD driver page. Please click **Install All** or follow the order from top to bottom to install those required drivers. Therefore, the drivers you install can work properly.

#### Utilities Menu

The Utilities Menu shows the application software that the motherboard supports. Click on a specific item then follow the installation wizard to install it.

## 3.2 ASRock Motherboard Utility (A-Tuning)

ASRock Motherboard Utility (A-Tuning) is ASRock's multi purpose software suite with a new interface, more new features and improved utilities.

### 3.2.1 Installing ASRock Motherboard Utility (A-Tuning)

ASRock Motherboard Utility (A-Tuning) can be downloaded from ASRock Live Update & APP Shop. After the installation, you will find the icon "ASRock Motherboard Utility (A-Tuning)" on your desktop. Double-click the "ASRock Motherboard Utility (A-Tuning)"  icon, ASRock Motherboard Utility (A-Tuning) main menu will pop up.

### 3.2.2 Using ASRock Motherboard Utility (A-Tuning)

There are four sections in ASRock Motherboard Utility (A-Tuning) main menu: Operation Mode, System Info, FAN-Tastic Tuning and Settings.

#### Operation Mode

Choose an operation mode for your computer.

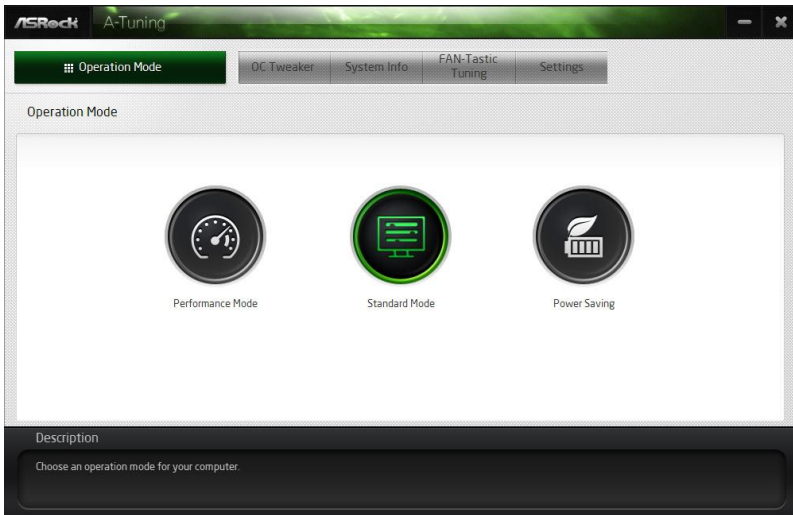

## System Info

View information about the system.

\*The System Browser tab may not appear for certain models.

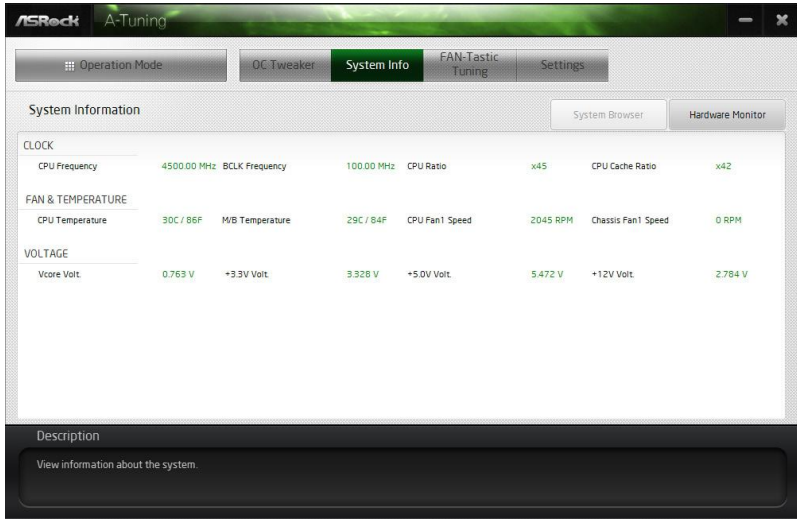

The screenshot shows the ASRock A-Tuning software interface with the 'System Info' tab selected. The interface includes a top navigation bar with 'Operation Mode', 'OC Tweaker', 'System Info', 'FAN-Tastic Tuning', and 'Settings'. Below this, there are buttons for 'System Browser' and 'Hardware Monitor'. The main content area is divided into three sections: 'CLOCK', 'FAN & TEMPERATURE', and 'VOLTAGE'. Each section contains a table of system metrics.

CLOCK							
CPU Frequency	4500.00 MHz	BCLK Frequency	100.00 MHz	CPU Ratio	x45	CPU Cache Ratio	x42

FAN & TEMPERATURE							
CPU Temperature	30C / 86F	MB Temperature	29C / 84F	CPU Fan1 Speed	2045 RPM	Chassis Fan1 Speed	0 RPM

  

VOLTAGE							
Core Volt	0.763 V	+3.3V Volt	3.328 V	+5.0V Volt	5.472 V	+12V Volt	2.784 V

At the bottom, there is a 'Description' section with the text: 'View information about the system.'

## FAN-Tastic Tuning

Configure up to five different fan speeds using the graph. The fans will automatically shift to the next speed level when the assigned temperature is met.

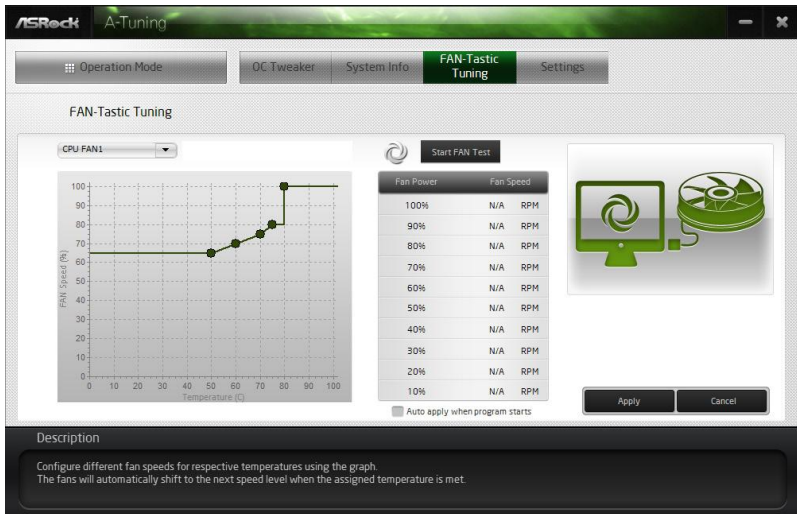

The screenshot shows the ASRock A-Tuning software interface with the 'FAN-Tastic Tuning' tab selected. The interface includes a top navigation bar with 'Operation Mode', 'OC Tweaker', 'System Info', 'FAN-Tastic Tuning', and 'Settings'. Below this, there are buttons for 'Start FAN Test' and 'Auto apply when program starts'. The main content area features a graph for 'CPU FAN1' showing 'Fan Speed (%)' vs 'Temperature (C)'. To the right of the graph is a table for configuring fan speeds.

Fan Power	Fan Speed
100%	N/A RPM
90%	N/A RPM
80%	N/A RPM
70%	N/A RPM
60%	N/A RPM
50%	N/A RPM
40%	N/A RPM
30%	N/A RPM
20%	N/A RPM
10%	N/A RPM

At the bottom, there is a 'Description' section with the text: 'Configure different fan speeds for respective temperatures using the graph. The fans will automatically shift to the next speed level when the assigned temperature is met.'

## Settings

Configure ASRock ASRock Motherboard Utility (A-Tuning). Click to select "Auto run at Windows Startup" if you want ASRock Motherboard Utility (A-Tuning) to be launched when you start up the Windows operating system.

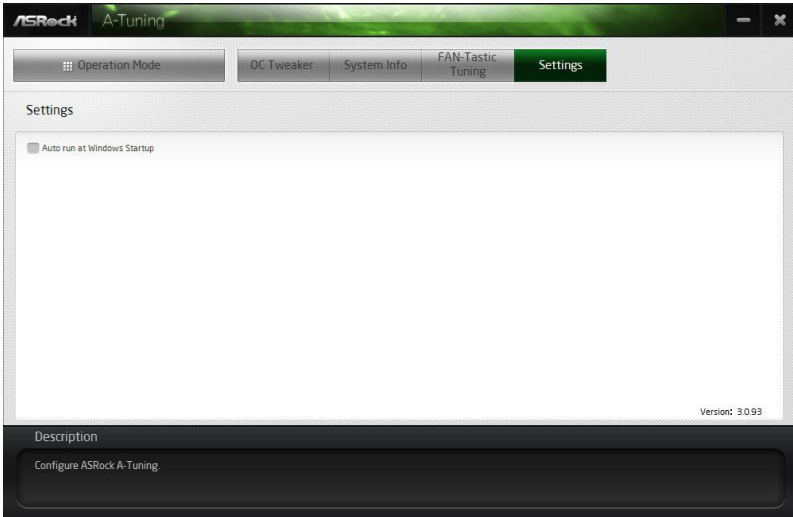



## 3.3 ASRock Live Update & APP Shop

The ASRock Live Update & APP Shop is an online store for purchasing and downloading software applications for your ASRock computer. You can quickly and easily install various apps and support utilities. With ASRock Live Update & APP Shop, you can optimize your system and keep your motherboard up to date simply with a few clicks.

Double-click  on your desktop to access ASRock Live Update & APP Shop utility.

*\*You need to be connected to the Internet to download apps from the ASRock Live Update & APP Shop.*

### 3.3.1 UI Overview



Information Panel

**Category Panel:** The category panel contains several category tabs or buttons that when selected the information panel below displays the relative information.

**Information Panel:** The information panel in the center displays data about the currently selected category and allows users to perform job-related tasks.

**Hot News:** The hot news section displays the various latest news. Click on the image to visit the website of the selected news and know more.

### 3.3.2 Apps

When the "Apps" tab is selected, you will see all the available apps on screen for you to download.

#### Installing an App

##### Step 1

Find the app you want to install.



The most recommended app appears on the left side of the screen. The other various apps are shown on the right. Please scroll up and down to see more apps listed.

You can check the price of the app and whether you have already installed it or not.

 - The red icon displays the price or "Free" if the app is free of charge.

 - The green "Installed" icon means the app is installed on your computer.

##### Step 2

Click on the app icon to see more details about the selected app.

### Step 3

If you want to install the app, click on the red icon  to start downloading.



### Step 4

When installation completes, you can find the green "Installed" icon appears on the upper right corner.



To uninstall it, simply click on the trash can icon .  
\*The trash icon may not appear for certain apps.

## Upgrading an App

You can only upgrade the apps you have already installed. When there is an available new version for your app, you will find the mark of "New Version" appears below the installed app icon.



### Step 1

Click on the app icon to see more details.

### Step 2

Click on the yellow icon  to start upgrading.

### 3.3.3 BIOS & Drivers

#### Installing BIOS or Drivers

When the "BIOS & Drivers" tab is selected, you will see a list of recommended or critical updates for the BIOS or drivers. Please update them all soon.

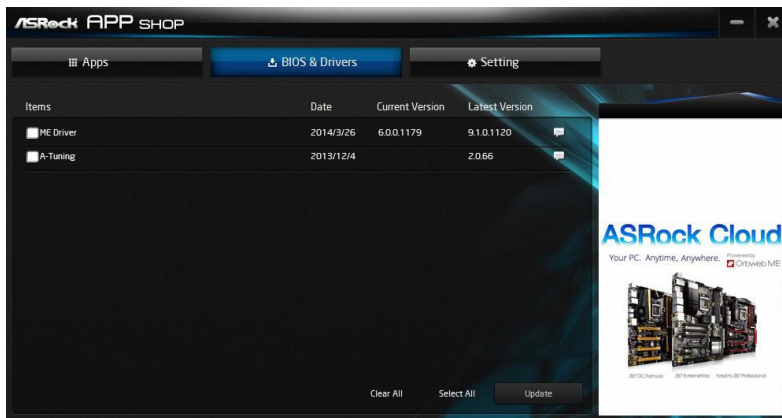

#### **Step 1**

Please check the item information before update. Click on  to see more details.

#### **Step 2**

Click to select one or more items you want to update.

#### **Step 3**

Click Update to start the update process.

### 3.3.4 Setting

In the "Setting" page, you can change the language, select the server location, and determine if you want to automatically run the ASRock Live Update & APP Shop on Windows startup.

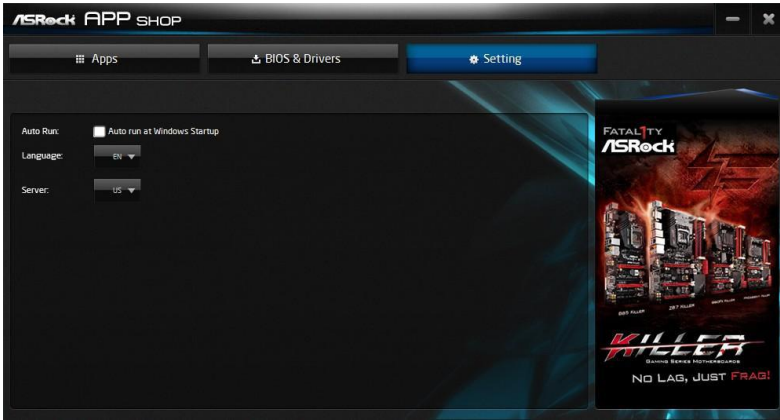

---

# Chapter 4 UEFI SETUP UTILITY

## 4.1 Introduction

This section explains how to use the UEFI SETUP UTILITY to configure your system. You may run the UEFI SETUP UTILITY by pressing <F2> or <Del> right after you power on the computer, otherwise, the Power-On-Self-Test (POST) will continue with its test routines. If you wish to enter the UEFI SETUP UTILITY after POST, restart the system by pressing <Ctl> + <Alt> + <Delete>, or by pressing the reset button on the system chassis. You may also restart by turning the system off and then back on.



*Because the UEFI software is constantly being updated, the following UEFI setup screens and descriptions are for reference purpose only, and they may not exactly match what you see on your screen.*

## 4.2 EZ Mode

The EZ Mode screen appears when you enter the BIOS setup program by default. EZ mode is a dashboard which contains multiple readings of the system's current status. You can check the most crucial information of your system, such as CPU speed, DRAM frequency, SATA information, fan speed, etc.

Press <F6> or click the "Advanced Mode" button at the upper right corner of the screen to switch to "Advanced Mode" for more options.

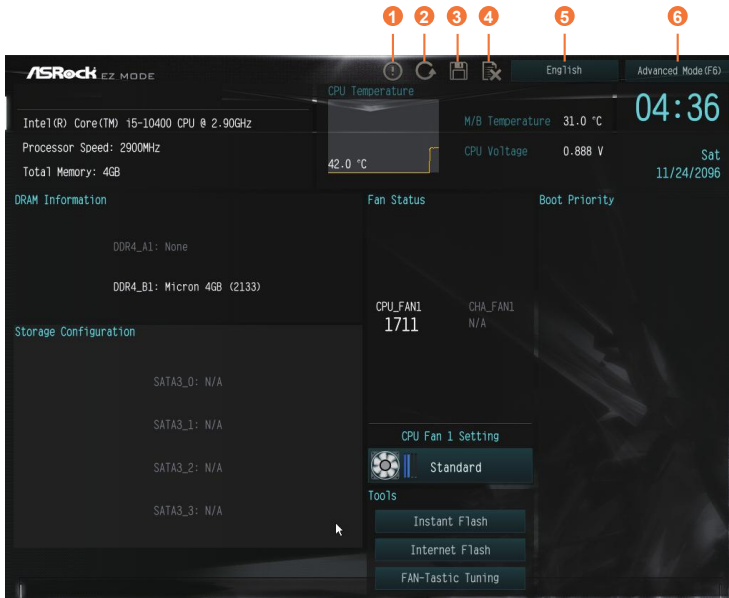

No.	Function
1	Help
2	Load UEFI Defaults
3	Save Changes and Exit
4	Discard Changes
5	Change Language
6	Switch to Advanced Mode



## 4.3 Advanced Mode

The Advanced Mode provides more options to configure the BIOS settings. Refer to the following sections for the detailed configurations.

To access the EZ Mode, press <F6> or click the "EZ Mode" button at the upper right corner of the screen.

### 4.3.1 UEFI Menu Bar

The top of the screen has a menu bar with the following selections:

<b>Main</b>	For setting system time/date information
<b>OC Tweaker</b>	For overclocking configurations
<b>Advanced</b>	For advanced system configurations
<b>Tool</b>	Useful tools
<b>H/W Monitor</b>	Displays current hardware status
<b>Security</b>	For security settings
<b>Boot</b>	For configuring boot settings and boot priority
<b>Exit</b>	Exit the current screen or the UEFI Setup Utility

### 4.3.2 Navigation Keys

Use <←> key or <→> key to choose among the selections on the menu bar, and use <↑> key or <↓> key to move the cursor up or down to select items, then press <Enter> to get into the sub screen. You can also use the mouse to click your required item.

Please check the following table for the descriptions of each navigation key.

Navigation Key(s)	Description
+ / -	To change option for the selected items
<Tab>	Switch to next function
<PGUP>	Go to the previous page
<PGDN>	Go to the next page
<HOME>	Go to the top of the screen
<END>	Go to the bottom of the screen
<F1>	To display the General Help Screen
<F5>	Add / Remove Favorite
<F7>	Discard changes and exit the SETUP UTILITY
<F9>	Load optimal default values for all the settings
<F10>	Save changes and exit the SETUP UTILITY
<F12>	Print screen
<ESC>	Jump to the Exit Screen or exit the current screen

## 4.4 Main Screen

When you enter the UEFI SETUP UTILITY, the Main screen will appear and display the system overview.



*The availability and location of BIOS settings can be different for different models and BIOS versions.*

### H470M-HDV:

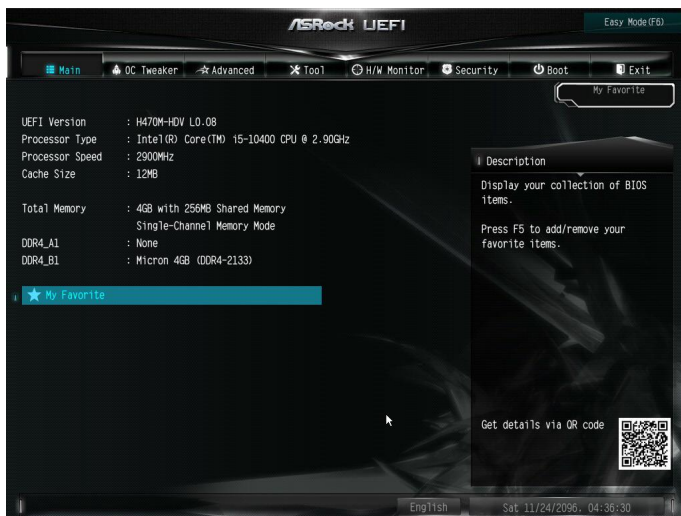

## H470M-HVS:

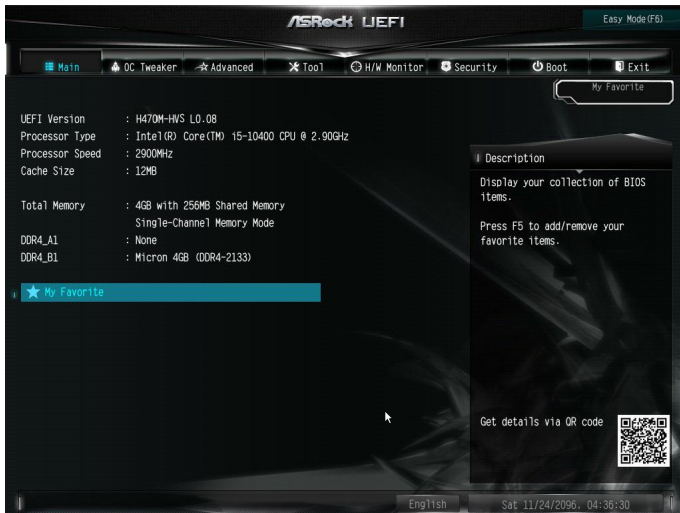

### My Favorite

Display your collection of BIOS items. Press F5 to add/remove your favorite items.

## 4.5 OC Tweaker Screen

In the OC Tweaker screen, you can set up overclocking features.



*Because the UEFI software is constantly being updated, the following UEFI setup screens and descriptions are for reference purpose only, and they may not exactly match what you see on your screen.*

### CPU Configuration

#### AVX2 Ratio Offset

AVX2 Ratio Offset specifies a negative offset from the CPU Ratio for AVX workloads. AVX is a more stressful workload that lower the AVX ratio to ensure maximum possible ratio for SSE workloads.

#### BCLK Spread Spectrum

Enable BCLK Spread Spectrum to reduce electromagnetic interference for passing EMI tests. Disable to achieve higher clock speeds when overclocking.

#### BCLK Aware Adaptive Voltage

BCLK Aware Adaptive Voltage enable/disable. When enabled, pcode will be aware of the BCLK frequency when calculating the CPU V/F curves. This is ideal for BCLK OC to avoid high voltage overrides.

## Boot Performance Mode

Select the performance state that the BIOS will set before OS handoff.

## FCLK Frequency

Configure the FCLK Frequency.

## Ring to Core Ratio Offset

Disable Ring to Core Ratio Offset so the ring and core can run at the same frequency.

## Intel SpeedStep Technology

Intel SpeedStep technology allows processors to switch between multiple frequencies and voltage points for better power saving and heat dissipation.

## Intel Turbo Boost Technology

Intel Turbo Boost Technology enables the processor to run above its base operating frequency when the operating system requests the highest performance state.

## Intel Speed Shift Technology

Enable/Disable Intel Speed Shift Technology support. Enabling will expose the CPPC v2 interface to allow for hardware controlled P-states.

## Intel Thermal Velocity Boost Voltage Optimizations

This service controls thermal based voltage optimizations for processors that implement the Intel Thermal Velocity Boost (TVB) feature.

## DRAM Configuration

### Memory Information

Allows users to browse the serial presence detect (SPD) and Intel extreme memory profile (XMP) for DDR4 modules.

### DRAM Timing Configuration

### Load XMP Setting

Load XMP settings to overclock the memory and perform beyond standard specifications.

### DRAM Frequency

If [Auto] is selected, the motherboard will detect the memory module(s) inserted and assign the appropriate frequency automatically.

## Primary Timing

### CAS# Latency (tCL)

The time between sending a column address to the memory and the beginning of the data in response.

### RAS# to CAS# Delay and Row Precharge (tRCDtRP)

RAS# to CAS# Delay : The number of clock cycles required between the opening of a row of memory and accessing columns within it.

Row Precharge: The number of clock cycles required between the issuing of the precharge command and opening the next row.

### RAS# Active Time (tRAS)

The number of clock cycles required between a bank active command and issuing the precharge command.

### Command Rate (CR)

The delay between when a memory chip is selected and when the first active command can be issued.

## Secondary Timing

### Write Recovery Time (tWR)

The amount of delay that must elapse after the completion of a valid write operation, before an active bank can be precharged.

### Refresh Cycle Time (tRFC)

The number of clocks from a Refresh command until the first Activate command to the same rank.

### RAS to RAS Delay (tRRD\_L)

The number of clocks between two rows activated in different banks of the same rank.

### RAS to RAS Delay (tRRD\_S)

The number of clocks between two rows activated in different banks of the same rank.

### Write to Read Delay (tWTR\_L)

The number of clocks between the last valid write operation and the next read command to the same internal bank.

### Write to Read Delay (tWTR\_S)

The number of clocks between the last valid write operation and the next read command to the same internal bank.

### Read to Precharge (tRTP)

The number of clocks that are inserted between a read command to a row pre-charge command to the same rank.

### Four Activate Window (tFAW)

The time window in which four activates are allowed the same rank.

### CAS Write Latency (tCWL)

Configure CAS Write Latency.

### Third Timing

#### tREFI

Configure refresh cycles at an average periodic interval.

#### tCKE

Configure the period of time the DDR4 initiates a minimum of one refresh command internally once it enters Self-Refresh mode.

### Turn Around Timing

#### tRDRD\_sg

Configure between module read to read delay.

#### tRDRD\_dg

Configure between module read to read delay.

#### tRDRD\_dr

Configure between module read to read delay.

#### tRDRD\_dd

Configure between module read to read delay.

#### tRDWR\_sg

Configure between module read to write delay.

#### tRDWR\_dg

Configure between module read to write delay.



---

**tRDWR\_dr**

Configure between module read to write delay.

**tRDWR\_dd**

Configure between module read to write delay.

**tWRRD\_sg**

Configure between module write to read delay.

**tWRRD\_dg**

Configure between module write to read delay.

**tWRRD\_dr**

Configure between module write to read delay.

**tWRRD\_dd**

Configure between module write to read delay.

**tWRWR\_sg**

Configure between module write to write delay.

**tWRWR\_dg**

Configure between module write to write delay.

**tWRWR\_dr**

Configure between module write to write delay.

**tWRWR\_dd**

Configure between module write to write delay.

## Round Trip Timing

### Round Trip Timing Optimization

Auto is enabled in general case.

### RTL Init Value

Configure round trip latency init value for round trip latency training.

### IO-L Init Value

Configure IO latency init value for IO latency training.

### RTL (CH A)

Configure round trip latency for channel A.

### RTL (CH B)

Configure round trip latency for channel B.

### IO-L (CH A)

Configure IO latency for channel A.

### IO-L (CH B)

Configure IO latency for channel B.

### IO-L Offset (CH A)

Configure IO latency offset for channel A.

### IO-L Offset (CH B)

Configure IO latency offset for channel B.

### RFR Delay (CH A)

Configure RFR Delay for Channel A.

### RFR Delay (CH B)

Configure RFR Delay for Channel B.

### ODT Setting

#### ODT WR (A1)

Configure the memory on die termination resistors' WR for channel A1.

#### ODT WR (B1)

Configure the memory on die termination resistors' WR for channel B1.

#### ODT NOM (A1)

Use this to change ODT (CH A1) Auto/Manual settings. The default is [Auto].

#### ODT NOM (B1)

Use this to change ODT (CH B1) Auto/Manual settings. The default is [Auto].

#### ODT PARK (A1)

Configure the memory on die termination resistors' PARK for channel A1.

## ODT PARK (B1)

Configure the memory on die termination resistors' PARK for channel B1.

## Advanced Setting

### ASRock Timing Optimization

Configure the fast path through the MRC.

### Realtime Memory Timing

Configure the realtime memory timings.

[Enabled] The system will allow performing realtime memory timing changes after MRC\_DONE.

### Command Tristate

Configure the Command Tristate Support.

### Exit On Failure

Configure the Exit On Failure for MRC training steps.

### Reset On Training Fail

Reset system if the MRC training fails.

### MRC Fast Boot

Enable Memory Fast Boot to skip DRAM memory training for booting faster.

## Voltage Configuration

### CPU Core/Cache Voltage

Input voltage for the processor by the external voltage regulator.

### GT Voltage

Configure the voltage for the integrated GPU.

### VCCST Voltage

Configure the voltage for the VCCST.

### PCH +1.0 Voltage

Configure the chipset voltage.

### DRAM Voltage

Use this to configure DRAM Voltage. The default value is [Auto].

### Save User Default

Type a profile name and press enter to save your settings as user default.

### Load User Default

Load previously saved user defaults.

### Save User UEFI Setup Profile to Disk

It helps you to save current UEFI settings as an user profile to disk.

### Load User UEFI Setup Profile from Disk

You can load previous saved profile from the disk.

## 4.6 Advanced Screen

In this section, you may set the configurations for the following items: CPU Configuration, Chipset Configuration, Storage Configuration, Super IO Configuration, ACPI Configuration, USB Configuration and Trusted Computing.



*Setting wrong values in this section may cause the system to malfunction.*

### UEFI Configuration

#### UEFI Setup Style

Select the default mode when entering the UEFI setup utility.

#### Active Page on Entry

Select the default page when entering the UEFI setup utility.

#### Full HD UEFI

When [Auto] is selected, the resolution will be set to 1920 x 1080 if the monitor supports Full HD resolution. If the monitor does not support Full HD resolution, then the resolution will be set to 1024 x 768. When [Disable] is selected, the resolution will be set to 1024 x 768 directly.

## 4.6.1 CPU Configuration



### Intel Hyper Threading Technology

Intel Hyper Threading Technology allows multiple threads to run on each core, so that the overall performance on threaded software is improved.

### Active Processor Cores

Select the number of cores to enable in each processor package.

### CPU C States Support

Enable CPU C States Support for power saving. It is recommended to keep C3, C6 and C7 all enabled for better power saving.

### Enhanced Halt State (C1E)

Enable Enhanced Halt State (C1E) for lower power consumption.

### CPU C3 State Support

Enable C3 deep sleep state for lower power consumption.

### CPU C6 State Support

Enable C6 deep sleep state for lower power consumption.

### CPU C7 State Support

Enable C7 deep sleep state for lower power consumption.

---

## Package C State Support

Enable CPU, PCIe, Memory, Graphics C State Support for power saving.

## CFG Lock

This item allows you to disable or enable the CFG Lock.

## C6DRAM

Enable/Disable moving of DRAM contents to PRM memory when CPU is in C6 state.

## Intel Virtualization Technology

Intel Virtualization Technology allows a platform to run multiple operating systems and applications in independent partitions, so that one computer system can function as multiple virtual systems.

## Hardware Prefetcher

Automatically prefetch data and code for the processor. Enable for better performance.

## Adjacent Cache Line Prefetch

Automatically prefetch the subsequent cache line while retrieving the currently requested cache line. Enable for better performance.

## Software Guard Extensions (SGX)

Intel SGX is a set of new CPU instructions that can be used by applications to set aside private regions of code and data.

## 4.6.2 Chipset Configuration



### Primary Graphics Adapter

Select a primary VGA.

### Above 4G Decoding

Enable or disable 64bit capable Devices to be decoded in Above 4G Address Space (only if the system supports 64 bit PCI decoding).

### VT-d

Intel® Virtualization Technology for Directed I/O helps your virtual machine monitor better utilize hardware by improving application compatibility and reliability, and providing additional levels of manageability, security, isolation, and I/O performance.

### SR-IOV Support

If system has SR-IOV capable PCIe Devices, this option Enables or Disables Single Root IO Virtualization Support.

### DMI Link Speed

Configure DMI Slot Link Speed. Auto mode is optimizing for overclocking.

### PCIE1 Link Speed

Select the link speed for PCIE1.



---

### PCIE2 Link Speed

Select the link speed for PCIE2.

### PCI Express Native Control

Select Enable for enhanced PCI Express power saving in OS.

### PCIE ASPM Support

This option enables/disables the ASPM support for all CPU downstream devices.

### PCH PCIE ASPM Support

This option enables/disables the ASPM support for all PCH PCIE devices.

### DMI ASPM Support

This option enables/disables the control of ASPM on CPU side of the DMI Link.

### PCH DMI ASPM Support

This option enables/disables the ASPM support for all PCH DMI devices.

### Share Memory

Configure the size of memory that is allocated to the integrated graphics processor when the system boots up.

### IGPU Multi-Monitor

Select disable to disable the integrated graphics when an external graphics card is installed. Select enable to keep the integrated graphics enabled at all times.

### Onboard LAN

Enable or disable the onboard network interface controller.

### Onboard HD Audio

Enable/disable onboard HD audio. Set to Auto to enable onboard HD audio and automatically disable it when a sound card is installed.

### Front Panel

Enable/disable front panel HD audio.

### Onboard HDMI HD Audio

Enable audio for the onboard digital outputs.

## Deep Sleep

Configure deep sleep mode for power saving when the computer is shut down.

## Restore on AC/Power Loss

Select the power state after a power failure. If [Power Off] is selected, the power will remain off when the power recovers. If [Power On] is selected, the system will start to boot up when the power recovers.

## 4.6.3 Storage Configuration



### SATA Controller(s)

Enable/disable the SATA controllers.

### SATA Mode Selection

AHCI: Supports new features that improve performance.

RAID: Combine multiple disk drives into a logical unit.

### SATA Aggressive Link Power Management

SATA Aggressive Link Power Management allows SATA devices to enter a low power state during periods of inactivity to save power. It is only supported by AHCI mode.

### Hard Disk S.M.A.R.T.

S.M.A.R.T stands for Self-Monitoring, Analysis, and Reporting Technology. It is a monitoring system for computer hard disk drives to detect and report on various indicators of reliability.

## 4.6.4 Super IO Configuration

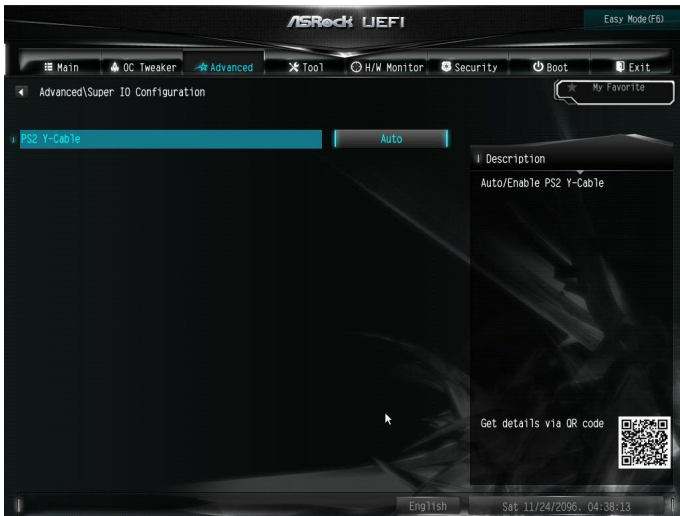

### PS2 Y-Cable

Enable the PS2 Y-Cable or set this option to Auto.

## 4.6.5 ACPI Configuration



### Suspend to RAM

Select disable for ACPI suspend type S1. It is recommended to select auto for ACPI S3 power saving.

### PS/2 Keyboard S4/S5 Wakeup Support

Allow the system to be waked up by a PS/2 Keyboard in S4/S5.

### PCIE Devices Power On

Allow the system to be waked up by a PCIE device and enable wake on LAN.

### RTC Alarm Power On

Allow the system to be waked up by the real time clock alarm. Set it to By OS to let it be handled by your operating system.

### USB Keyboard/Remote Power On

Allow the system to be waked up by an USB keyboard or remote controller.

### USB Mouse Power On

Allow the system to be waked up by an USB mouse.

## 4.6.6 USB Configuration

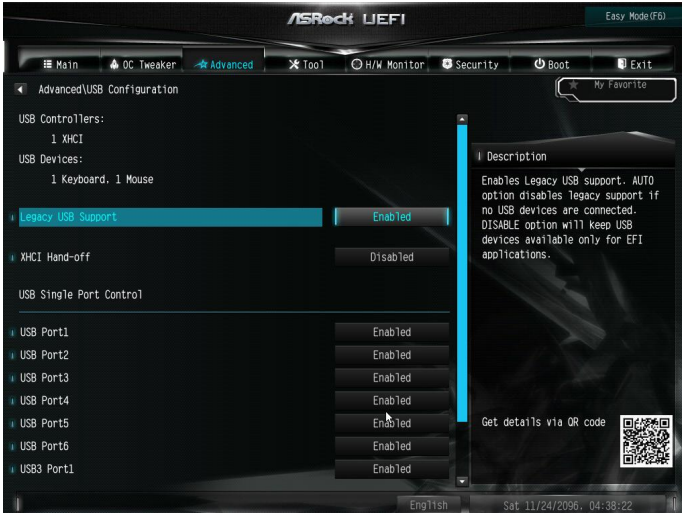

### Legacy USB Support

Enable or disable Legacy OS Support for USB 2.0 devices. If you encounter USB compatibility issues it is recommended to disable legacy USB support. Select UEFI Setup Only to support USB devices under the UEFI setup and Windows/Linux operating systems only.

### XHCI Hand-off

This is a workaround for OSes without XHCI hand-off support. The XHCI ownership change should be claimed by XHCI driver.

## 4.6.7 Trusted Computing



### Security Device Support

Enable or disable BIOS support for security device.

## 4.7 Tools

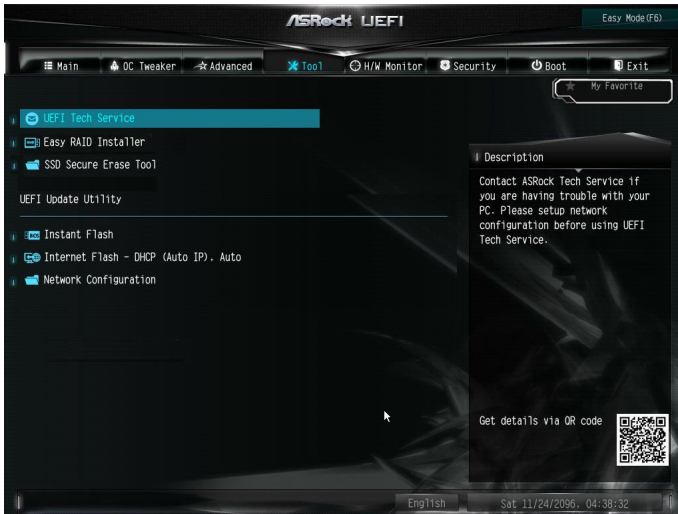

### UEFI Tech Service

Contact ASRock Tech Service if you are having trouble with your PC. Please setup network configuration before using UEFI Tech Service.

### Easy RAID Installer

Easy RAID Installer helps you to copy the RAID driver from the support CD to your USB storage device. After copying the drivers please change the SATA mode to RAID, then you can start installing the operating system in RAID mode.

### SSD Secure Erase Tool

All the SSD's listed that supports Secure Erase function.

### Instant Flash

Save UEFI files in your USB storage device and run Instant Flash to update your UEFI.

### Internet Flash - DHCP (Auto IP), Auto

ASRock Internet Flash downloads and updates the latest UEFI firmware version from our servers for you. Please setup network configuration before using Internet Flash.

\*For BIOS backup and recovery purpose, it is recommended to plug in your USB pen drive before using this function.



## Network Configuration

Use this to configure internet connection settings for Internet Flash.

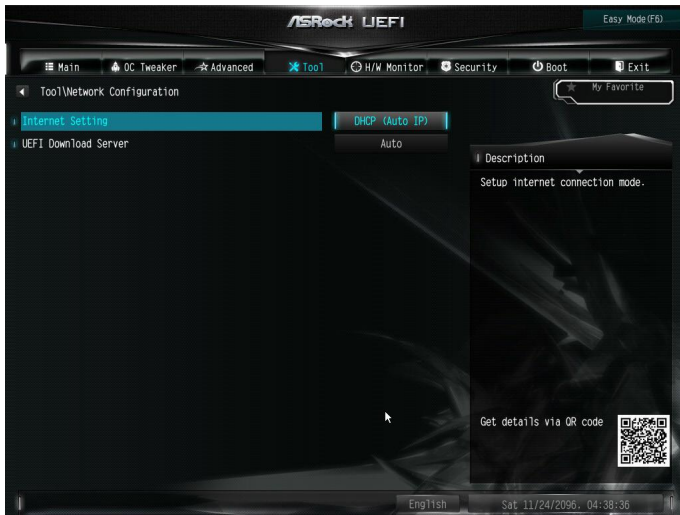

### Internet Setting

Enable or disable sound effects in the setup utility.

### UEFI Download Server

Select a server to download the UEFI firmware.

## 4.8 Hardware Health Event Monitoring Screen

This section allows you to monitor the status of the hardware on your system, including the parameters of the CPU temperature, motherboard temperature, fan speed and voltage.

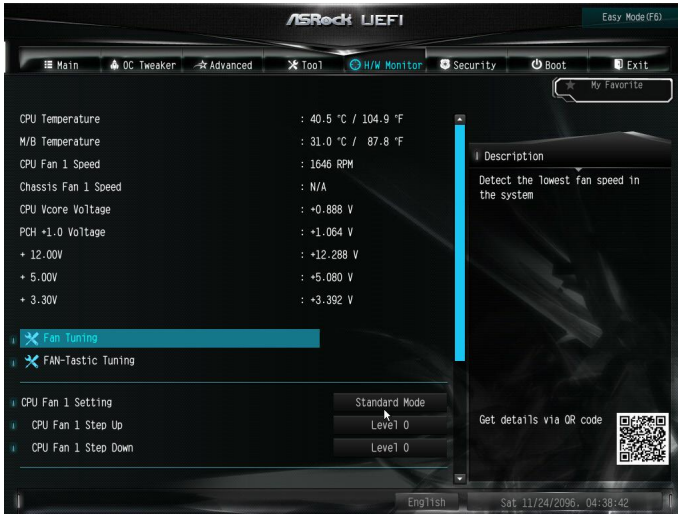

### Fan Tuning

Measure Fan Min Duty Cycle.

### Fan-Tastic Tuning

Select a fan mode for CPU Fan, or choose Customize to set 5 CPU temperatures and assign a respective fan speed for each temperature.

### CPU Fan 1 Setting

Select a fan mode for CPU Fan 1, or choose Customize to set 5 CPU temperatures and assign a respective fan speed for each temperature.

### CPU Fan 1 Step Up

Set the value of CPU Fan Step Up.

### CPU Fan 1 Step Down

Set the value of CPU Fan Step Down.

### CHA\_FAN1 / W\_Pump Switch

Select CHA\_FAN1 / W\_Pump mode.

---

## Chassis Fan 1 Control Mode

Select PWM mode or DC mode for CHA\_FAN1.

## Chassis Fan 1 Setting

Select a fan mode for CHA\_FAN1, or choose Customize to set 5 CPU temperatures and assign a respective fan speed for each temperature.

## Chassis Fan 1 Temp Source

Select a fan temperature source for Chassis Fan 1.

## Chassis Fan 1 Step Up

Set the value of Chassis Fan 1 Step Up.

## Chassis Fan 1 Step Down

Set the value of Chassis Fan 1 Step Down.

## Case Open Feature

Enable or disable Case Open Feature to detect whether the chassis cover has been removed.

## 4.9 Security Screen

In this section you may set or change the supervisor/user password for the system. You may also clear the user password.



### Supervisor Password

Set or change the password for the administrator account. Only the administrator has authority to change the settings in the UEFI Setup Utility. Leave it blank and press enter to remove the password.

### User Password

Set or change the password for the user account. Users are unable to change the settings in the UEFI Setup Utility. Leave it blank and press enter to remove the password.

### Secure Boot

Use this item to enable or disable support for Secure Boot.

### Intel(R) Platform Trust Technology

Enable/disable Intel PTT in ME. Disable this option to use discrete TPM Module.

## 4.10 Boot Screen

This section displays the available devices on your system for you to configure the boot settings and the boot priority.



### Fast Boot

Fast Boot minimizes your computer's boot time. In fast mode you may not boot from an USB storage device. The VBIOS must support UEFI GOP if you are using an external graphics card. Please notice that Ultra Fast mode will boot so fast that the only way to enter this UEFI Setup Utility is to Clear CMOS or run the Restart to UEFI utility in Windows.

### Boot From Onboard LAN

Allow the system to be waked up by the onboard LAN.

### Setup Prompt Timeout

Configure the number of seconds to wait for the setup hot key.

### Bootup Num-Lock

Select whether Num Lock should be turned on or off when the system boots up.

### Boot Beep

Select whether the Boot Beep should be turned on or off when the system boots up. Please note that a buzzer is needed.

## Full Screen Logo

Enable to display the boot logo or disable to show normal POST messages.

## AddOn ROM Display

Enable AddOn ROM Display to see the AddOn ROM messages or configure the AddOn ROM if you've enabled Full Screen Logo. Disable for faster boot speed.

## Boot Failure Guard Message

If the computer fails to boot for a number of times the system automatically restores the default settings.

## CSM (Compatibility Support Module)

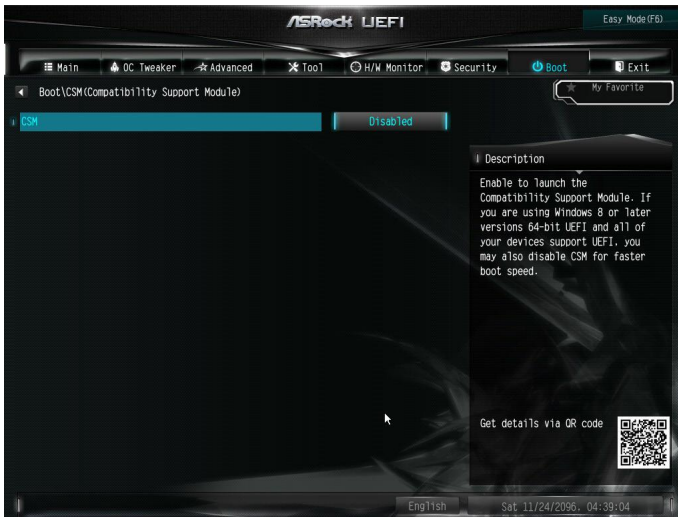

## CSM

Enable to launch the Compatibility Support Module. Please do not disable unless you're running a WHCK test.

## Launch PXE OpROM Policy

Select UEFI only to run those that support UEFI option ROM only. Select Legacy only to run those that support legacy option ROM only. Select Do not launch to not execute both legacy and UEFI option ROM.

---

## Launch Storage OpROM Policy

Select UEFI only to run those that support UEFI option ROM only. Select Legacy only to run those that support legacy option ROM only. Select Do not launch to not execute both legacy and UEFI option ROM.

## Other PCI Device ROM Priority

For PCI devices other than Network. Mass storage or Video defines which OpROM to launch.

## 4.11 Exit Screen

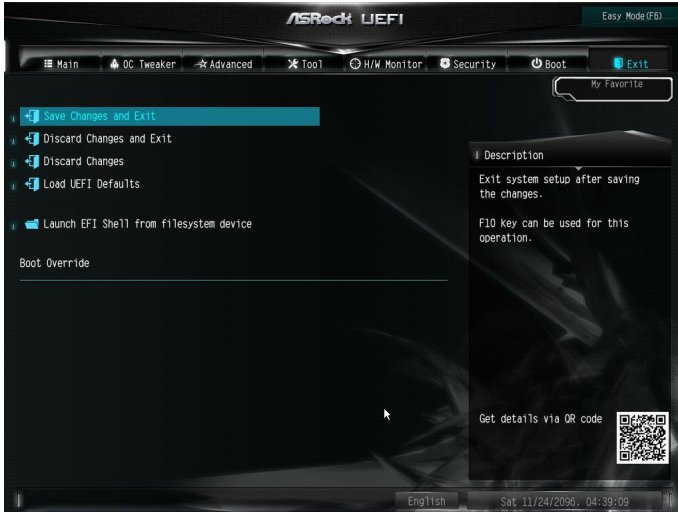

### Save Changes and Exit

When you select this option the following message, “Save configuration changes and exit setup?” will pop out. Select [OK] to save changes and exit the UEFI SETUP UTILITY.

### Discard Changes and Exit

When you select this option the following message, “Discard changes and exit setup?” will pop out. Select [OK] to exit the UEFI SETUP UTILITY without saving any changes.

### Discard Changes

When you select this option the following message, “Discard changes?” will pop out. Select [OK] to discard all changes.

### Load UEFI Defaults

Load UEFI default values for all options. The F9 key can be used for this operation.

### Launch EFI Shell from filesystem device

Copy shellx64.efi to the root directory to launch EFI Shell.



## **Contact Information**

If you need to contact ASRock or want to know more about ASRock, you're welcome to visit ASRock's website at <http://www.asrock.com>; or you may contact your dealer for further information. For technical questions, please submit a support request form at <http://www.asrock.com/support/tsd.asp>

### **ASRock Incorporation**

2F., No.37, Sec. 2, Jhongyang S. Rd., Beitou District,

Taipei City 112, Taiwan (R.O.C.)

### **ASRock EUROPE B.V.**

Bijsterhuizen 11-11

6546 AR Nijmegen

The Netherlands

Phone: +31-24-345-44-33

Fax: +31-24-345-44-38

### **ASRock America, Inc.**

13848 Magnolia Ave, Chino, CA91710

U.S.A.

Phone: +1-909-590-8308

Fax: +1-909-590-1026

# DECLARATION OF CONFORMITY

Per FCC Part 2 Section 2.1077(a)



**Responsible Party Name:** ASRock Incorporation

**Address:** 13848 Magnolia Ave, Chino, CA91710

**Phone/Fax No:** +1-909-590-8308/+1-909-590-1026

hereby declares that the product

**Product Name :** Motherboard

**Model Number :** H470M-HDV / H470M-HVS

Conforms to the following specifications:

FCC Part 15, Subpart B, Unintentional Radiators

## **Supplementary Information:**

This device complies with part 15 of the FCC Rules. Operation is subject to the following two conditions: (1) This device may not cause harmful interference, and (2) this device must accept any interference received, including interference that may cause undesired operation.

Representative Person's Name: James

Signature:

A handwritten signature in black ink, appearing to read 'James', written over a horizontal line.

Date : May 12, 2017

# EU Declaration of Conformity



For the following equipment:

**Motherboard**

(Product Name)

**H470M-HDV / H470M-HVS / ASRock**

(Model Designation / Trade Name)

**ASRock Incorporation**

(Manufacturer Name)

**2F., No.37, Sec. 2, Jhongyang S. Rd., Beitou District, Taipei City 112, Taiwan (R.O.C.)**

(Manufacturer Address)

**EMC — Directive 2014/30/EU (from April 20th, 2016)**

EN 55022:2010/AC:2011 Class B

EN 55024:2010/A1:2015

EN 55032:2012+AC:2013 Class B

EN 61000-3-3:2013

EN 61000-3-2:2014

**LVD — Directive 2014/35/EU (from April 20th, 2016)**

EN 60950-1 : 2011+ A2: 2013

EN 60950-1 : 2006/A12: 2011

RoHS — Directive 2011/65/EU

CE marking

(EU conformity marking)



**ASRock EUROPE B.V.**

(Company Name)

**Bijsterhuizen 1111 6546 AR Nijmegen The Netherlands**

(Company Address)

Person responsible for making this declaration:

(Name, Surname)

**A.V.P**

(Position / Title)

**January 25, 2021**

(Date)

P/N: 15G062278000AK V1.0